

SQM5... Reversing Actuator with Line Voltage Input Signal

Product Description

Reversing actuator used to position flow control valves, butterfly valves, dampers, or any application requiring rotary motion with line voltage input signal for Position Proportioning or Floating Control.

Product Numbers

SQM5x.xxxRxAx for line voltage input signals

Actuator Torque:	Max Shaft Torque:
SQM50.2... 90 in/lb	AGA58.1 200 in/lb
SQM50.3... 90 in/lb	AGA58.3 220 in/lb
SQM50.4... 140 in/lb	AGA58.4 270 in/lb
SQM53.4... 200 in/lb	AGA58.7 400 in/lb
SQM56.5... 310 in/lb	
SQM56.6... 400 in/lb	

SQM... motors allow torque on either end of the AGA58.3 and AGA58.4 shafts.

NOTE: For detailed information, see Technical Instructions 155-517P25.

Caution Notation

CAUTION:		Equipment damage may occur if procedures are not followed as specified.
-----------------	---	---

Installation

Cover Removal

Use a Phillips screwdriver to loosen the two screws on the actuator cover corners. See Figure 1.

Lift the screws and raise the cover. See Figure 2.

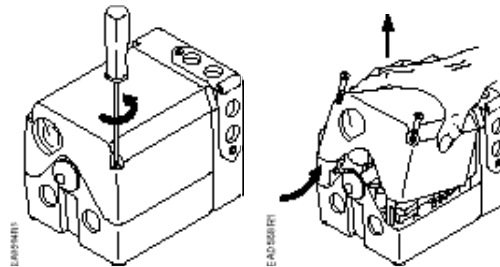

Figure 1.

Figure 2.

Rotational Direction Verification

Actuator model numbers that end with "R" are factory configured for clockwise (cw), minimum to maximum rotation when facing the gear end of the actuator, or counterclockwise (ccw) rotation when facing the other end of the actuator. The gear end of the actuator is the side opposite of the visual position indicator

Actuator Mounting

SQM5... actuators can be mounted in any orientation. Optional base mounting brackets are available.

SQM5... actuators can also be face-mounted using self-tapping screws in combination with the various holes on the face of the actuator gear end.

Switch Adjustment

SQM5... actuators are factory-wired with Switch I (maximum), Switch II (fully closed/economy position) and Switch III (minimum/low-fire). The individual switch cams I, II, and III are factory set to 90°, 0° and 10°, respectively. See Figures 3 and 4.

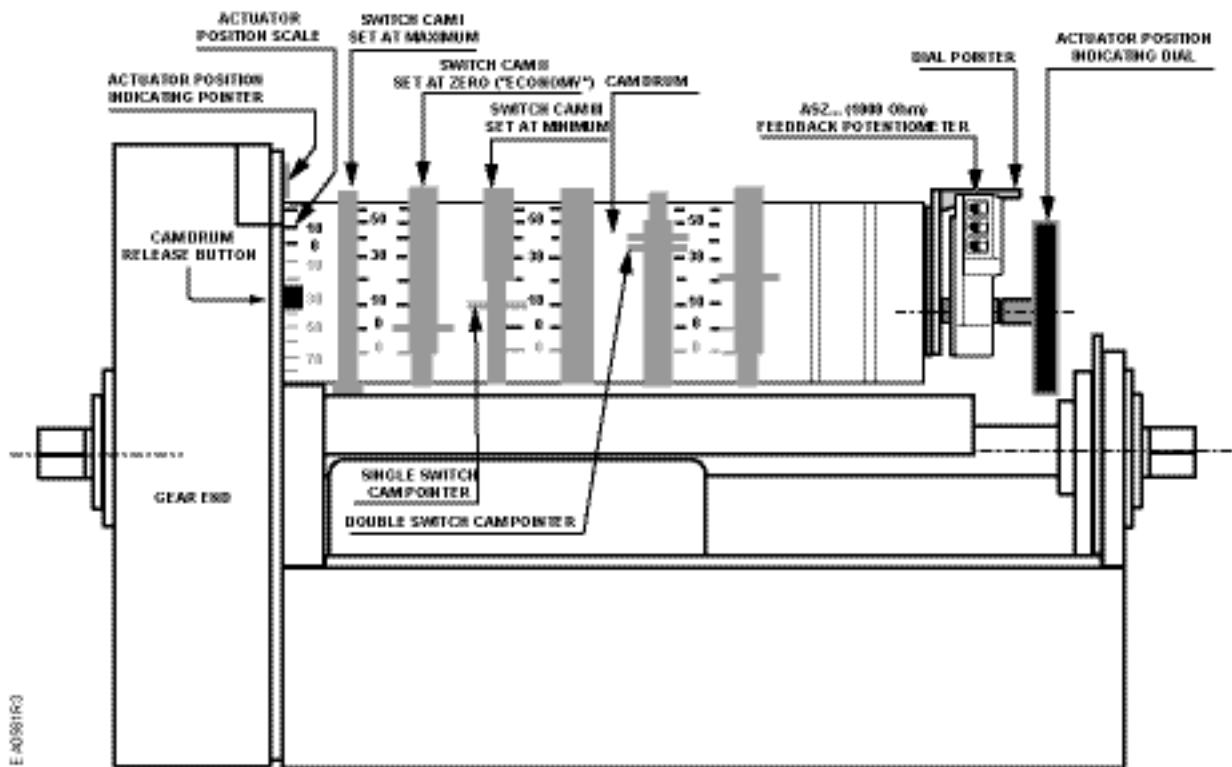

Figure 3. Component Identification on the Cam Drum Side of the SQM5...Actuator.

- NOTE:** The single switch cam pointers are used together with the black scales when configured for ccw operation.
- The double switch cam pointers are used together with the red scales when configured for cw operation.
- The individual switch cams can be adjusted by hand or with the use of the tool attached to the outside of the hinged switch terminal protection lid.
- SQM5x.xxxRxA actuators without potentiometer must be adjusted only between 0° and 160°.
- If a potentiometer is installed, the adjustable range of the switches depends on the range of the potentiometer.
- SQM5x.xxxRxA3 actuators have a 90° potentiometer and the switches must be adjusted between 0° and 90°.
- SQM5x.xxxRxA4 actuators have a 135° potentiometer and the switches must be adjusted between 0° and 135°.

Shaft Adjustment

The actuator shaft can be disengaged by pressing the silver shaft release button. The button is located above the grounding screw, under the hinged terminal protection cover, and to the right of the auto/manual switch. After pressing the shaft release button in and slightly upward, the shaft can be manually rotated. After the shaft has been manually aligned to the closed position, re-engage the shaft by pushing the shaft release button downwards.

Cam Drum Adjustment

Once the shaft has been set, the cam drum must be manually aligned by pressing and holding the black cam drum release button (see Figure 3). Rotate the cam drum until the "0" mark on the actuator position scale (left scale on the cam drum) is aligned with the gray actuator position indicating pointer.

Position Indicating Dial Adjustment

The actual position of the SQM5... actuator is indicated by the gray actuator position indicating pointer (see Figure 3). The position is also displayed by the indicating dial through the housing's window. Ensure that the actuator position indicating dial is aligned with the actuator position scale. If necessary, rotate the dial in the clockwise direction.



CAUTION:

Turning the dial in the counterclockwise direction may loosen the potentiometer locking screw.

Electrical Connection

SQM5... actuators are equipped with two removable conduit connection plates located on the upper corner of the gear housing. Each plate is provided with two threaded connections for 1/2-inch NPSM conduit connectors. The use of flexible 14 gauge or smaller stranded wire is recommended.

NOTE: SQM5... Actuators require a single-source, single-phase power supply.

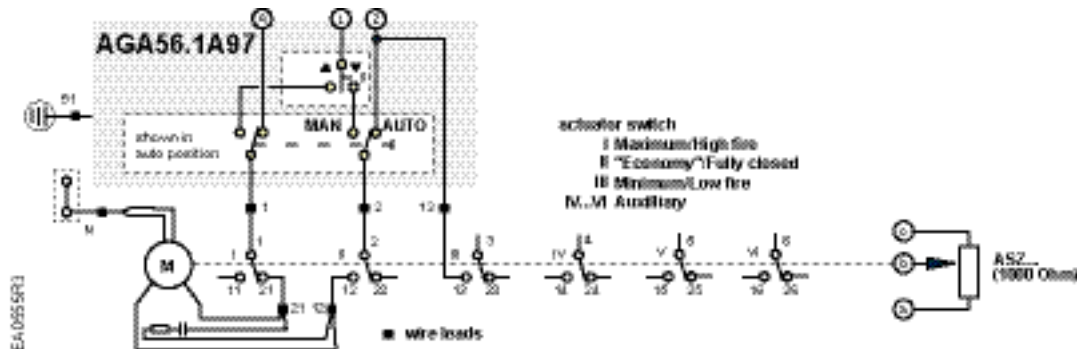

Figure 4. Basic Functional Diagram of AGA56.1...

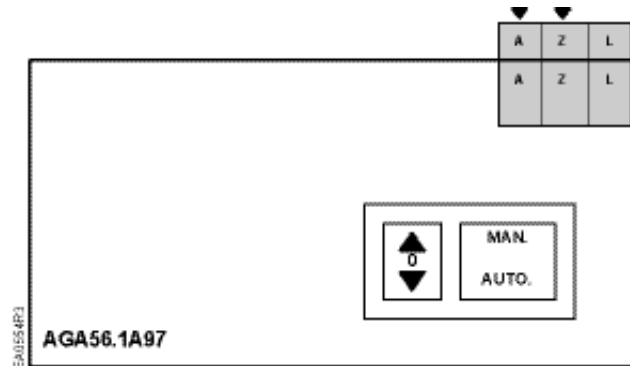

Figure 5 AGA56.1A97 Terminal and Auto-Manual Board.

Commissioning

Manual Operation

1. Set the AUTO/MAN switch in the MAN position.
2. Connect ground to the screw located below the shaft release button.
3. Connect neutral to the double terminal block, located on the left side of the gray switch housing.
4. Only terminal "L" must be powered to enable manual operation. The actuator can now be driven to the maximum position (switch cam I) or the fully closed "economy position" (switch cam II) by using the toggle switch located to the left of the AUTO/MAN switch.

Automatic Operation

1. Set the AUTO/MAN switch in the AUTO position.
2. Connect ground to the screw located below the shaft release button.
3. Connect neutral to the double terminal block, located on the left side of the gray switch housing.
4. Connect line voltage to terminal A to drive the actuator in the opening direction.
5. Connect line voltage to terminal Z to drive the actuator in the closing direction.



CAUTION:

Actuator damage will result if power is supplied to terminals A and Z simultaneously.

- Use feedback potentiometer ASZ... for Position Proportioning Control. This potentiometer is located at the end of the cam drum.

For information on potentiometer installation, see *Technical Instructions 155-517P25*.

Cover Installation

- Lift the two screws on the cover corners and slide the cover end into the groove at the gear end of the actuator (See Figure 6).
- Press the cover into place and then press the screws inward and tighten (See Figure 7).

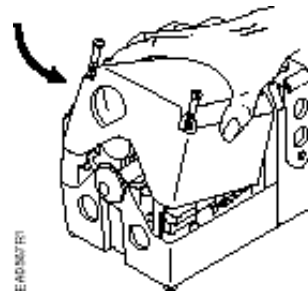

Figure 6.

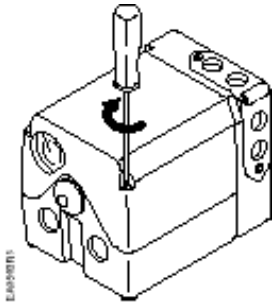

Figure 7.

The installation is now complete.

Dimensions

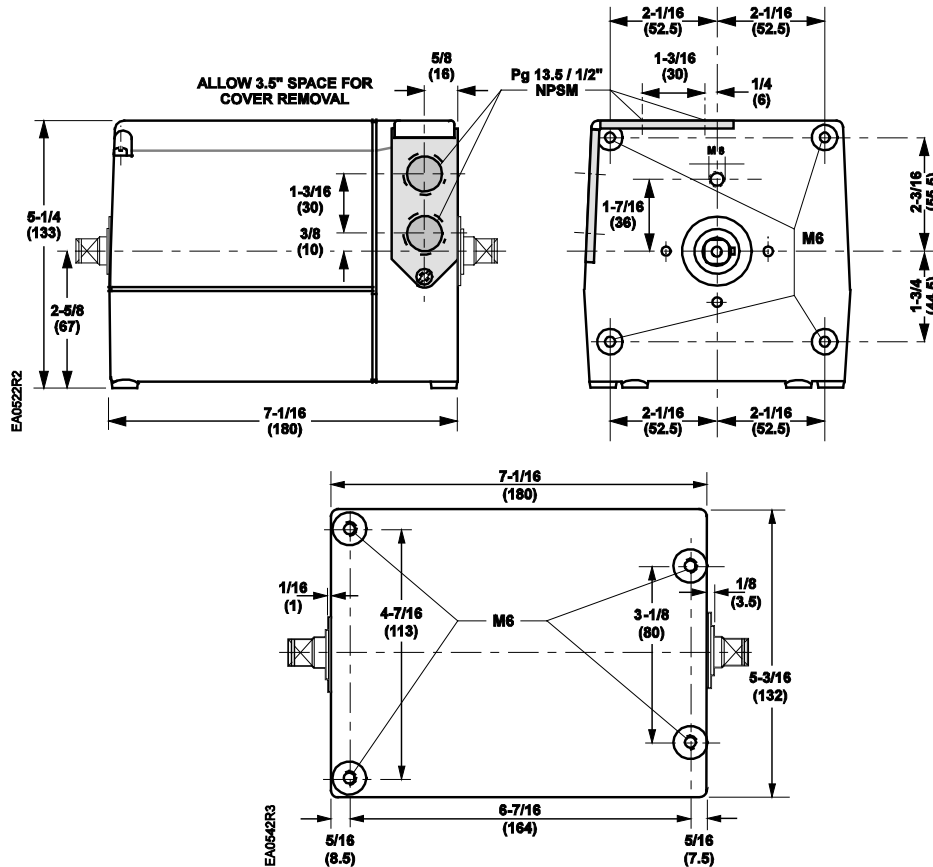

Figure 8. SQM5x.xxxRxx Dimensions in Inches (Millimeters).

Information in this publication is based on current specifications. The company reserves the right to make changes in specifications and models as design improvements are introduced. Product or company names mentioned herein may be the trademarks of their respective owners.
 © 2009 Siemens Industry, Inc.